

**DEPLACEMENT INDIVIDUEL**  
**"OUVERTURE OBSTRUEE"**

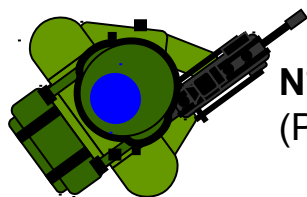

N°1 : ANALYSE DE L'OUVERTURE  
(PIEGES, SENS D'OUVERTURE...)

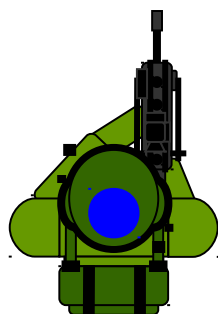

N°1 : SURVEILLANCE DE  
L'OUVERTURE

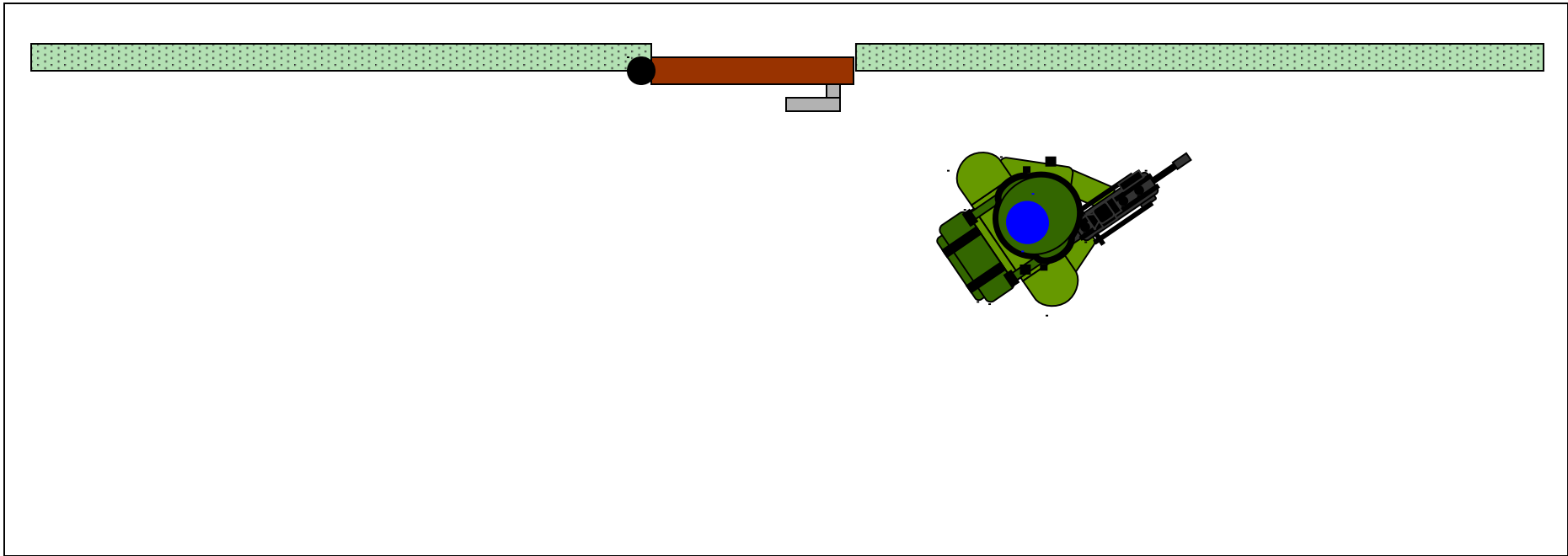
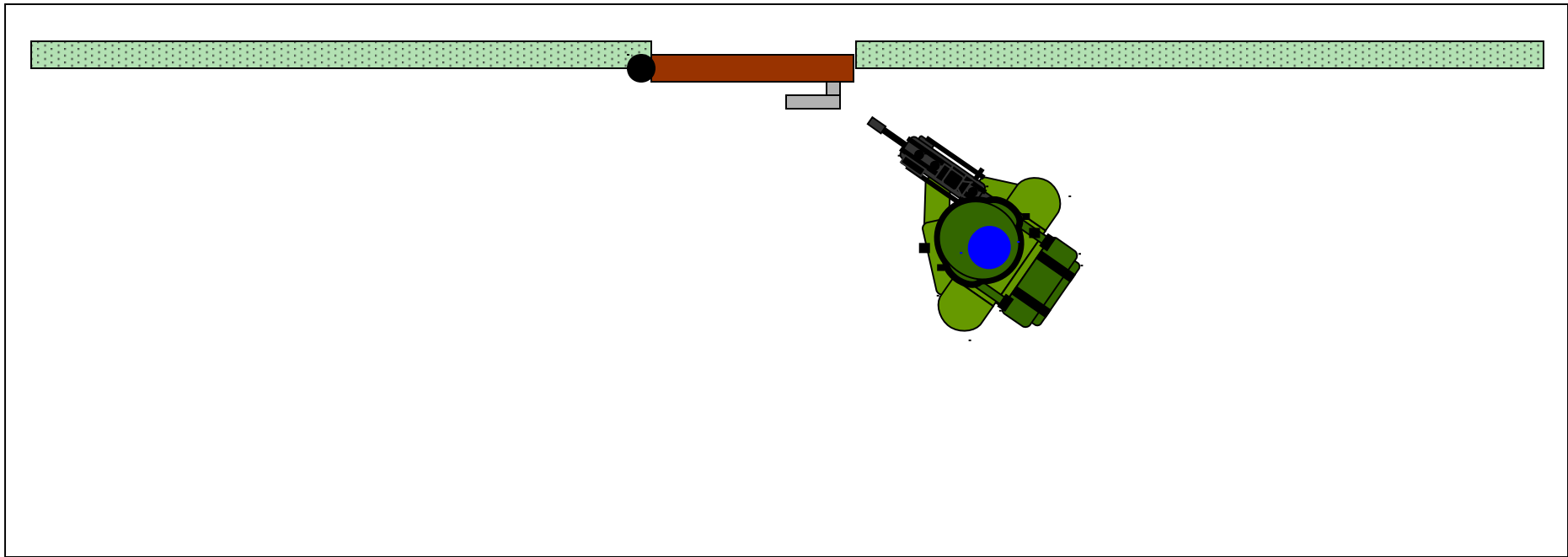

**DEPLACEMENT INDIVIDUEL**

**"OUVERTURE NON OBSTRUEE"**

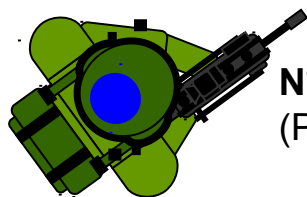

N°1 : ANALYSE DE L'OUVERTURE  
(PIEGES, SENS D'OUVERTURE...)

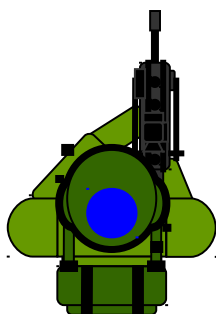

N°1 : SURVEILLANCE DE  
L'OUVERTURE

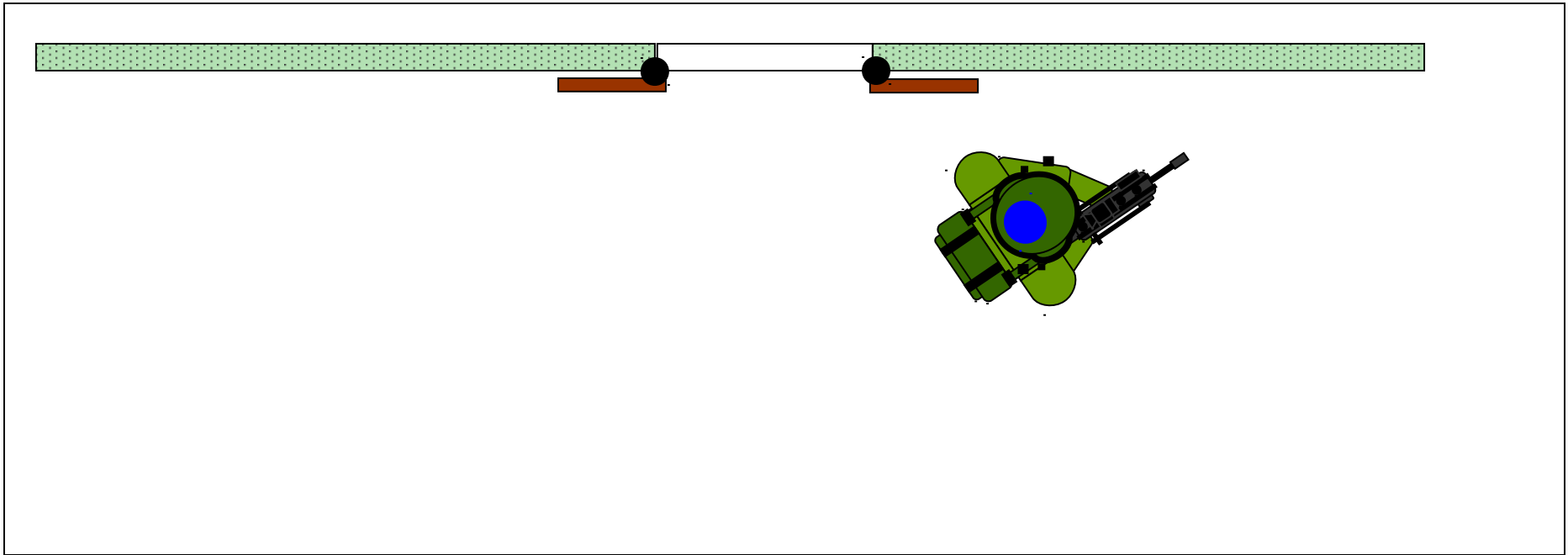
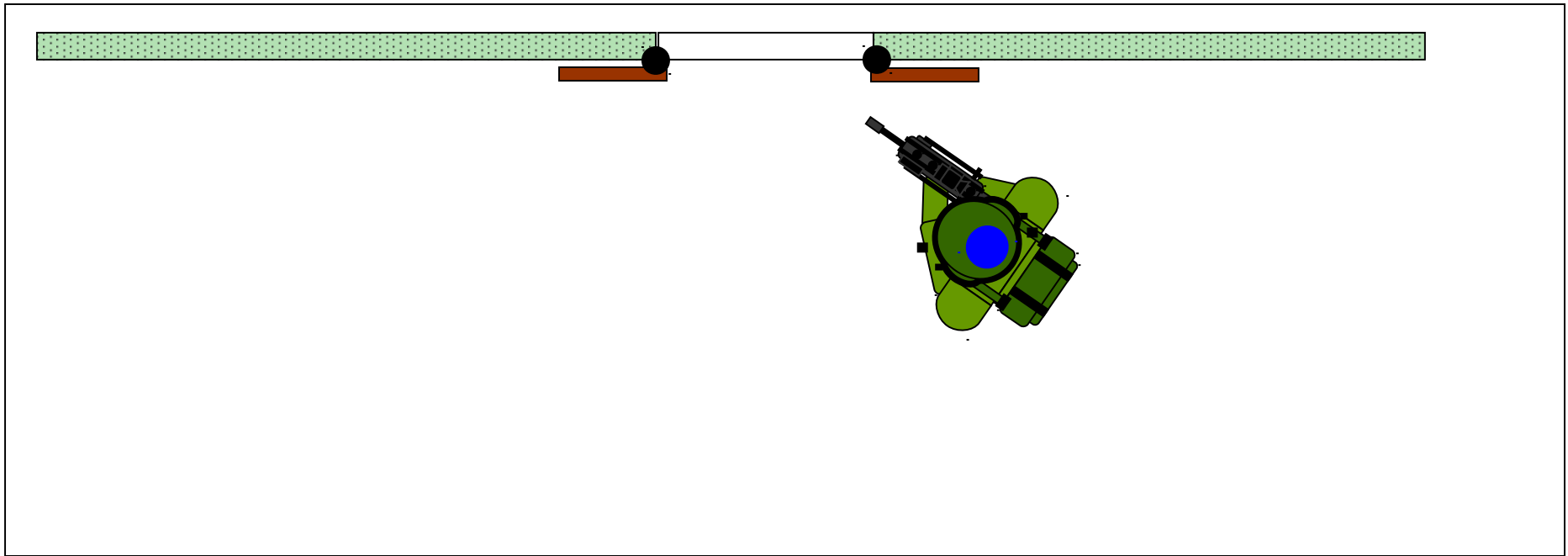

**LE TRINÔME**

**EN COMBAT EN LOCALITE**

# ORGANISATION DU TRINÔME

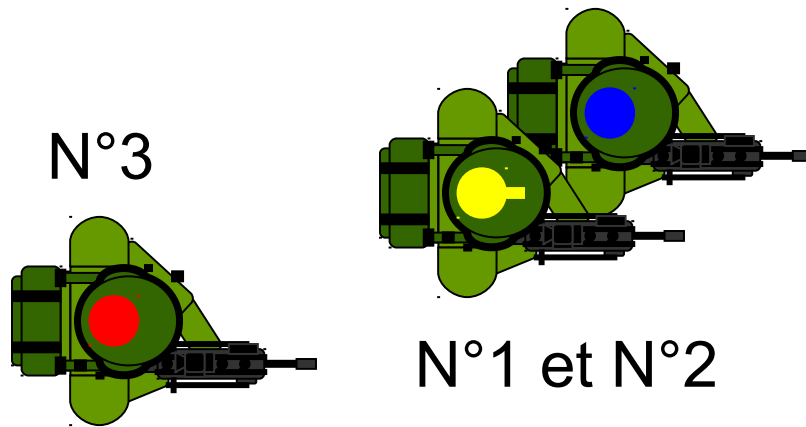

**NB** : UN ELEMENT APPUI  
UN ELEMENT PROGRESSE

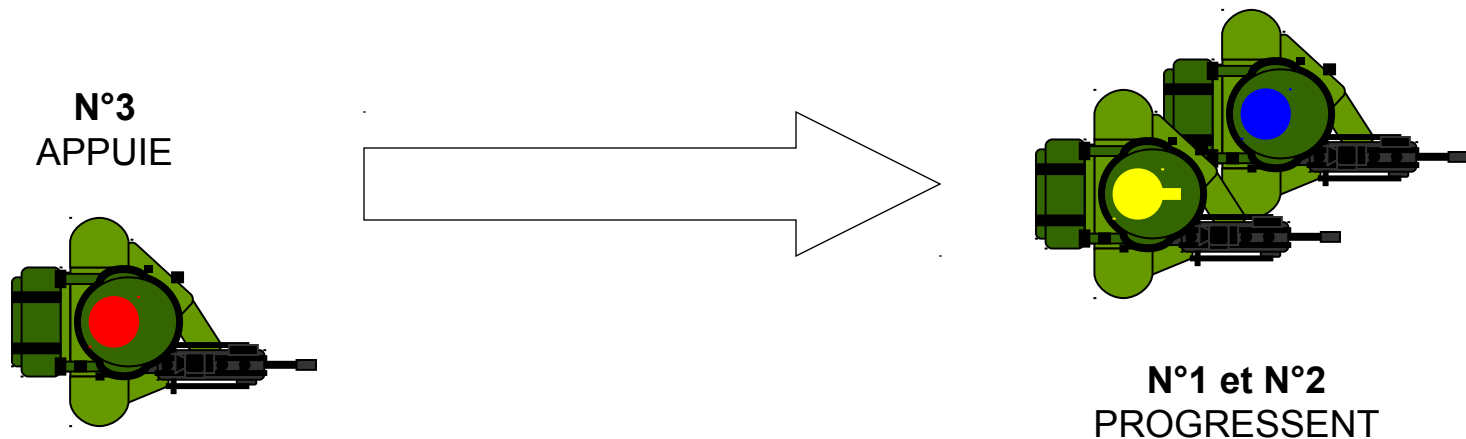



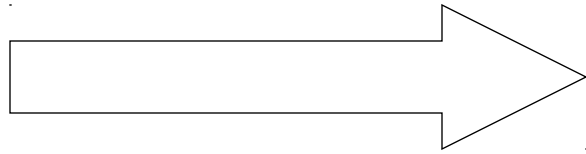

**N°3  
PROGRESSE**

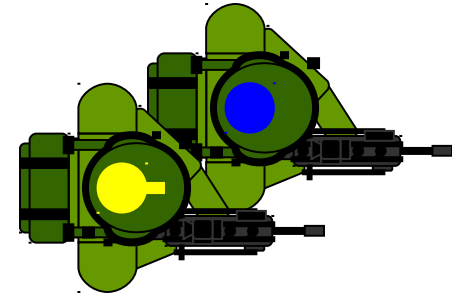
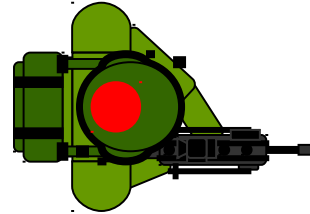

**N°1 et N°2  
APPUIENT**

## LES SECTEURS DE TIR ET DE SURVEILLANCE

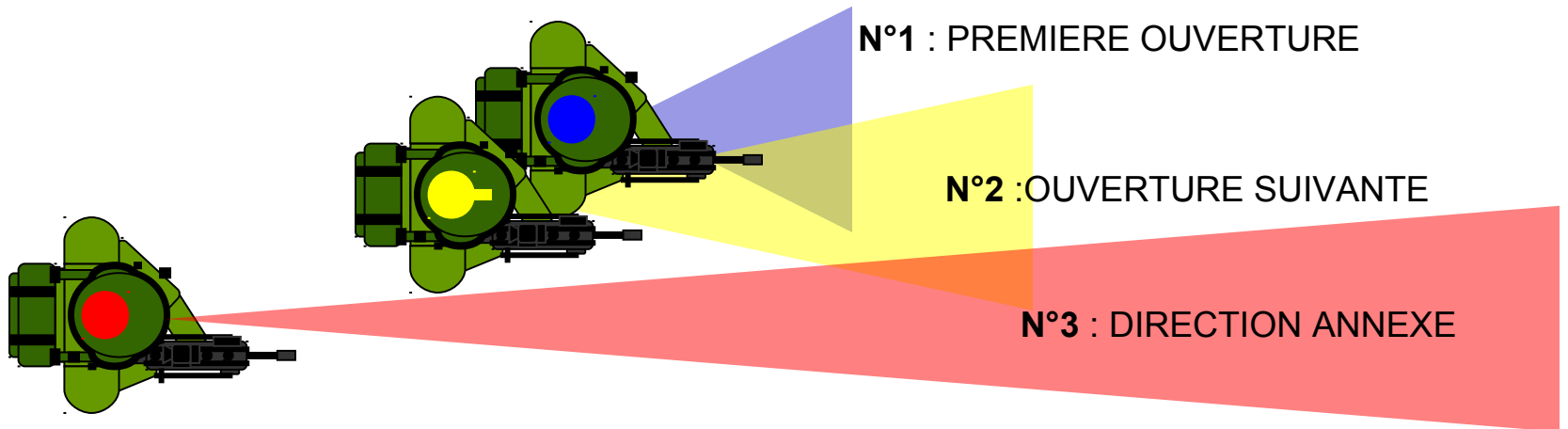

# POSITIONNEMENT

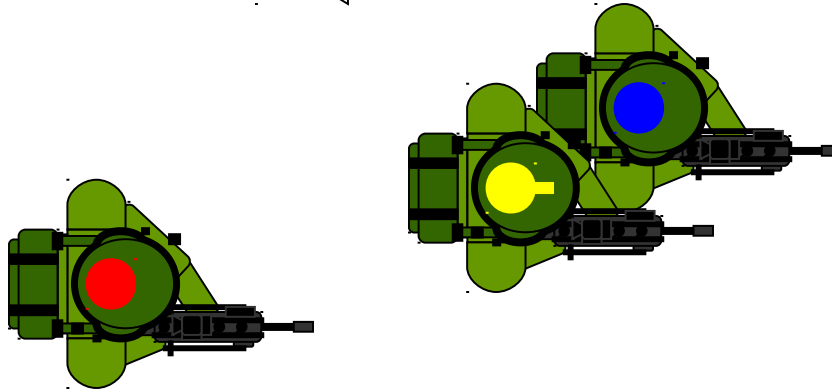

**NB** : DISTANCE D'ENVIRON UN BRAS  
ENTRE LE MUR ET N°1  
POUR PERMETTRE LE PASSAGE

**DEPLACEMENT TRINOME**

**"OUVERTURE OBSTRUEE, NON OBSTRUEE"**

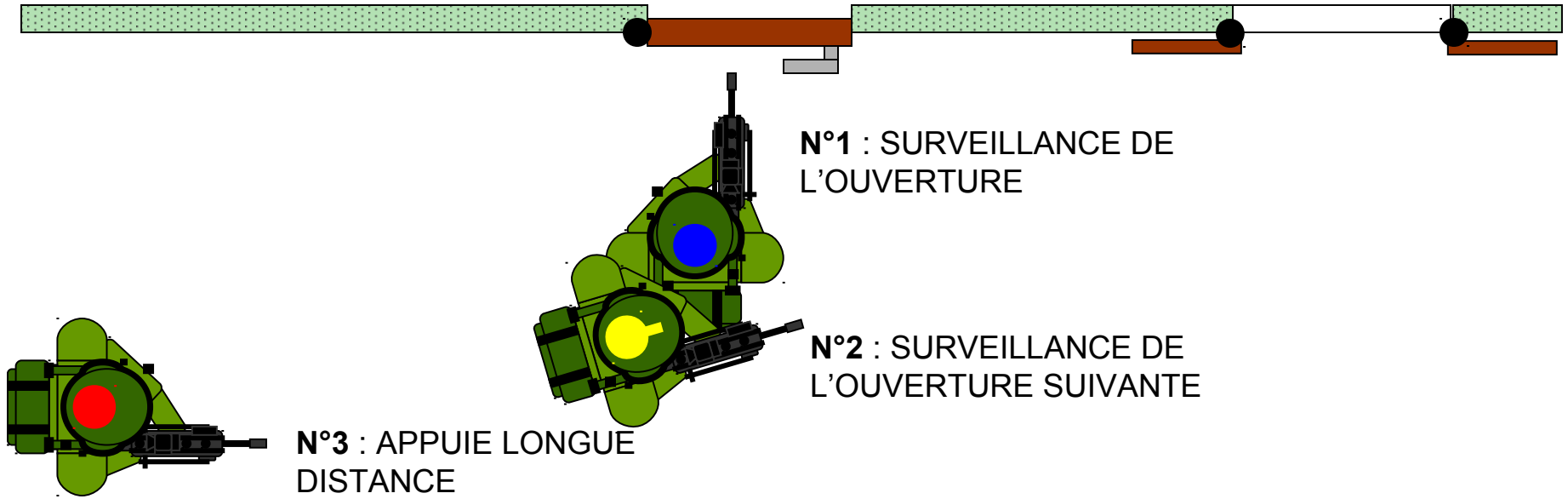
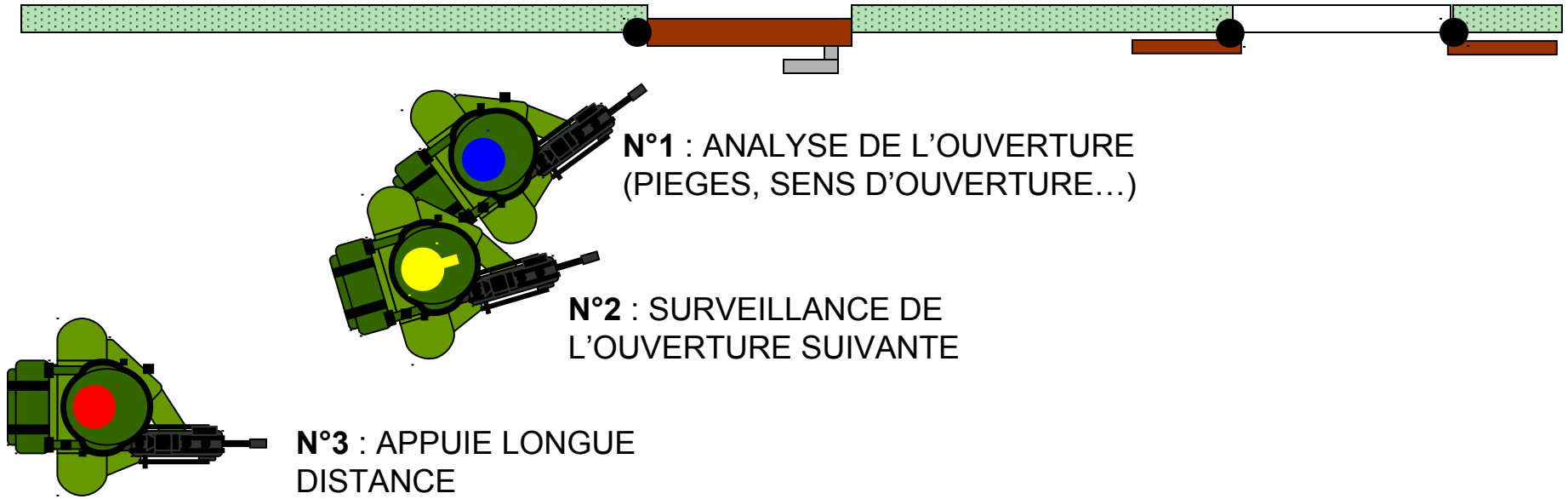

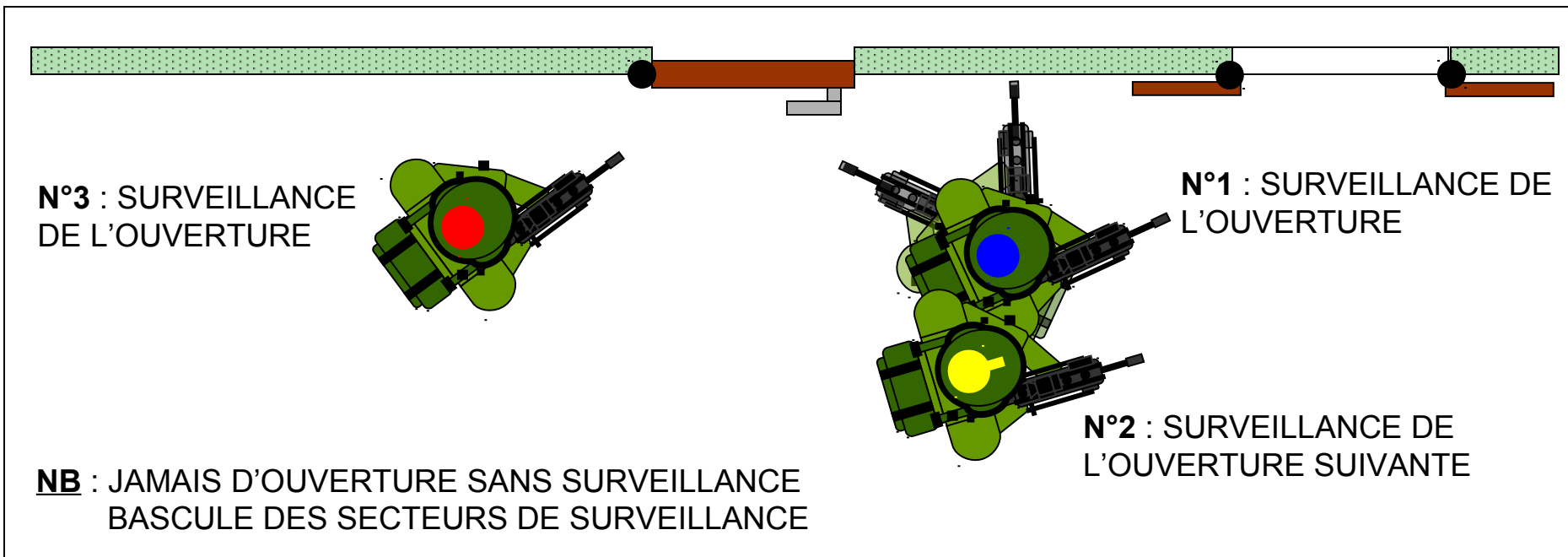
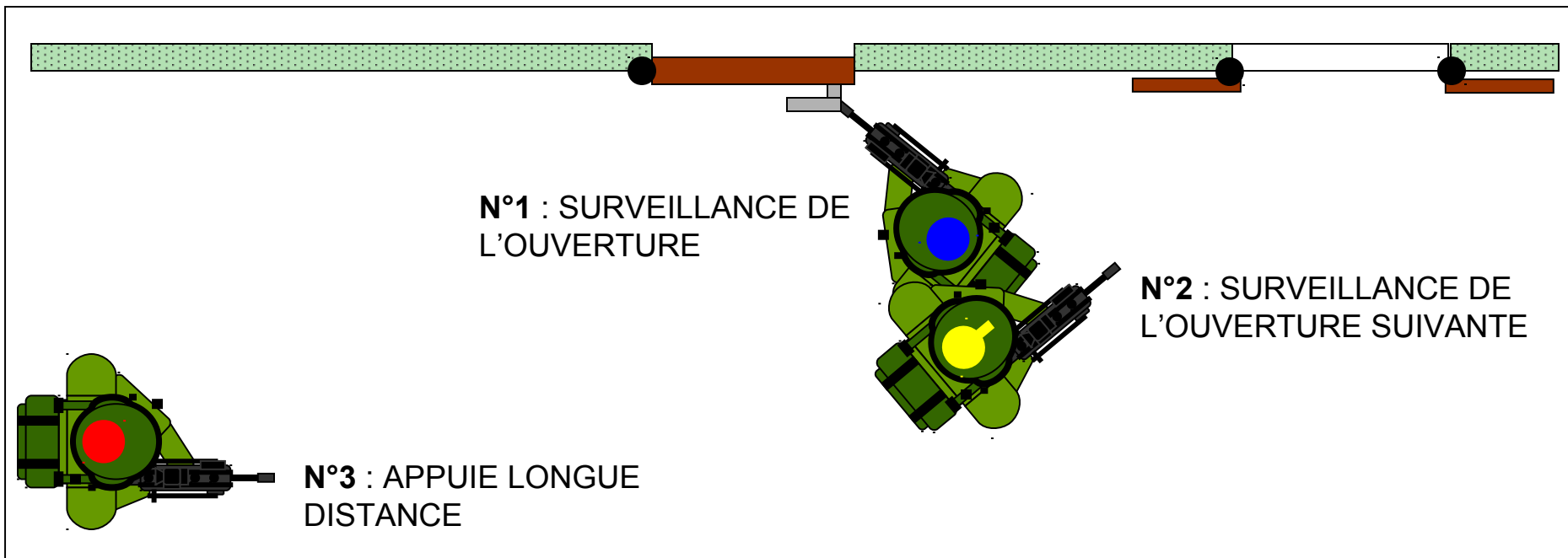

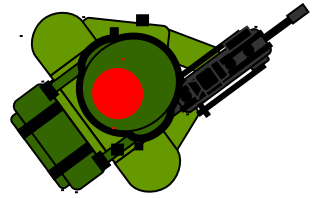
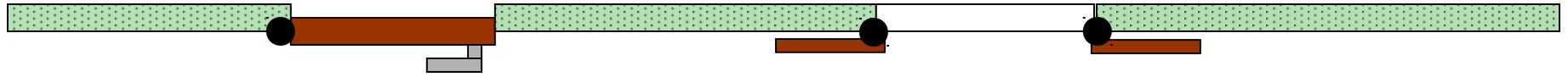

**N°3** : SURVEILLANCE  
DE L'OUVERTURE

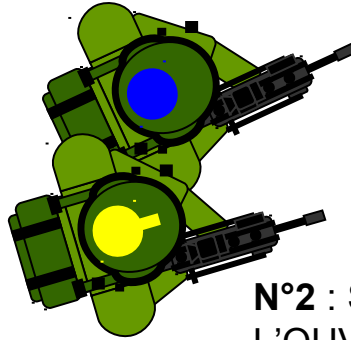

**N°2** : SURVEILLANCE DE  
L'OUVERTURE SUIVANTE

**N°1** : ANALYSE DE L'OUVERTURE  
(PIEGES, SENS D'OUVERTURE...)

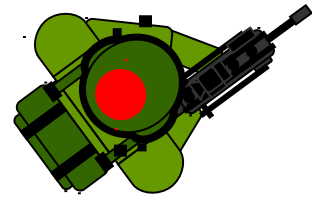
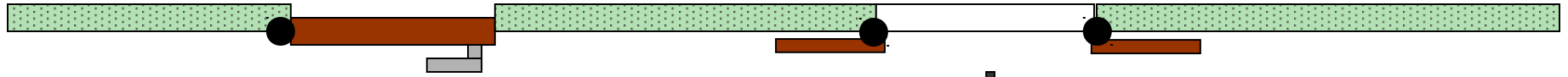

**N°3** : SURVEILLANCE  
DE L'OUVERTURE

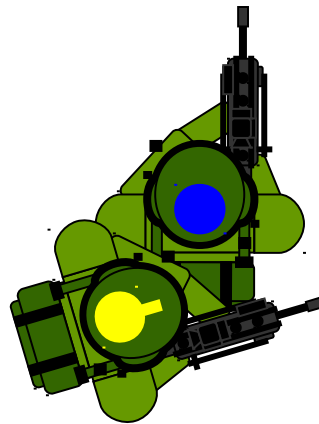

**N°1** : SURVEILLANCE DE  
L'OUVERTURE

**N°2** : SURVEILLANCE DE  
L'OUVERTURE SUIVANTE

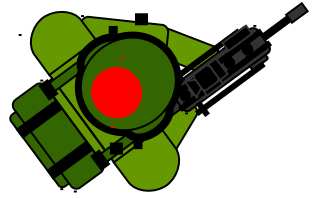
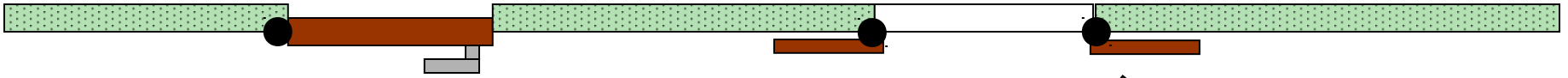

**N°3 : SURVEILLANCE  
DE L'OUVERTURE**

**N°1 : SURVEILLANCE DE  
L'OUVERTURE**

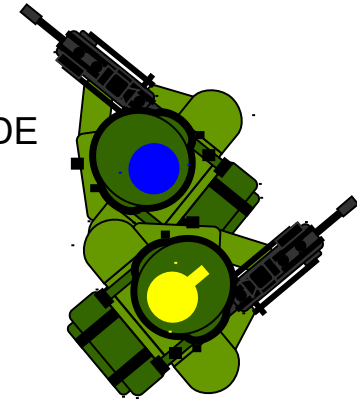

**N°2 : SURVEILLANCE DE  
L'OUVERTURE SUIVANTE**

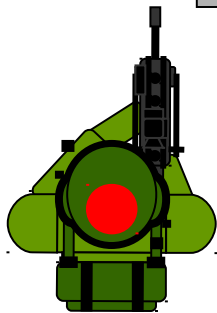
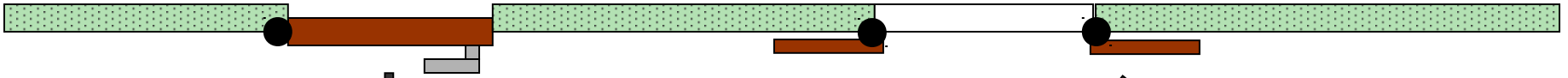

**N°3 : SURVEILLANCE  
DE L'OUVERTURE**

**N°1 : SURVEILLANCE DE  
L'OUVERTURE**

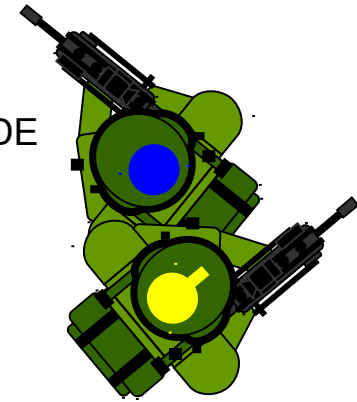

**N°2 : SURVEILLANCE DE  
L'OUVERTURE SUIVANTE**

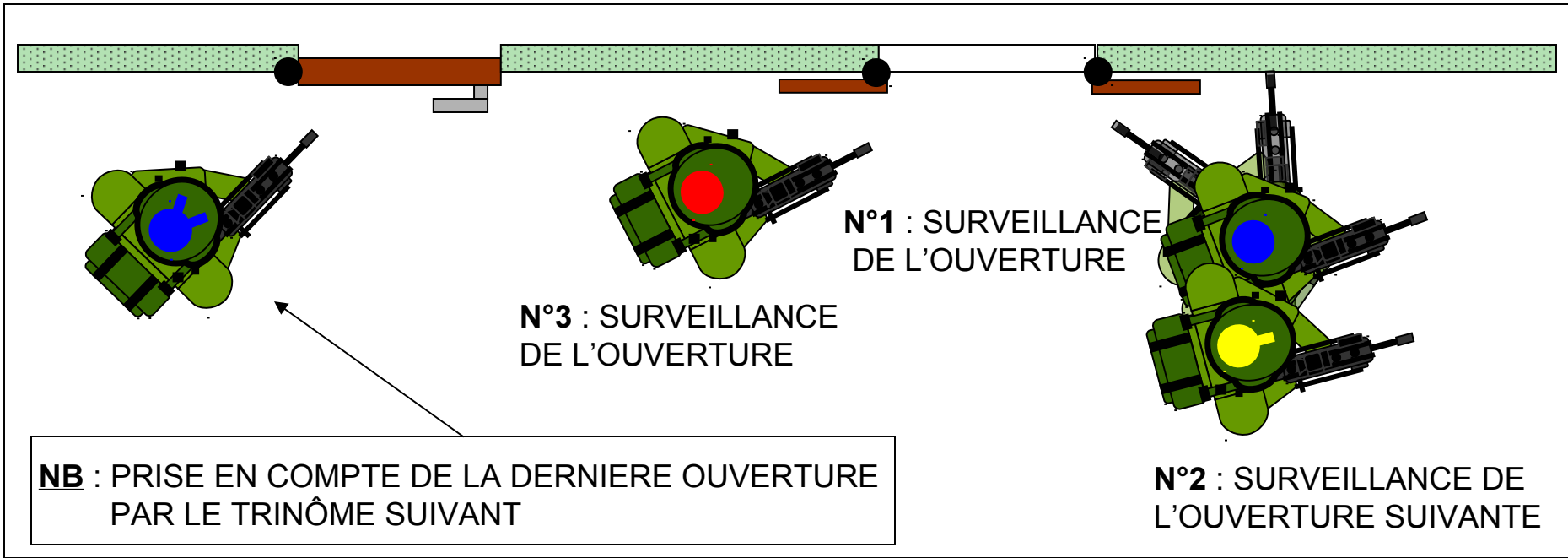
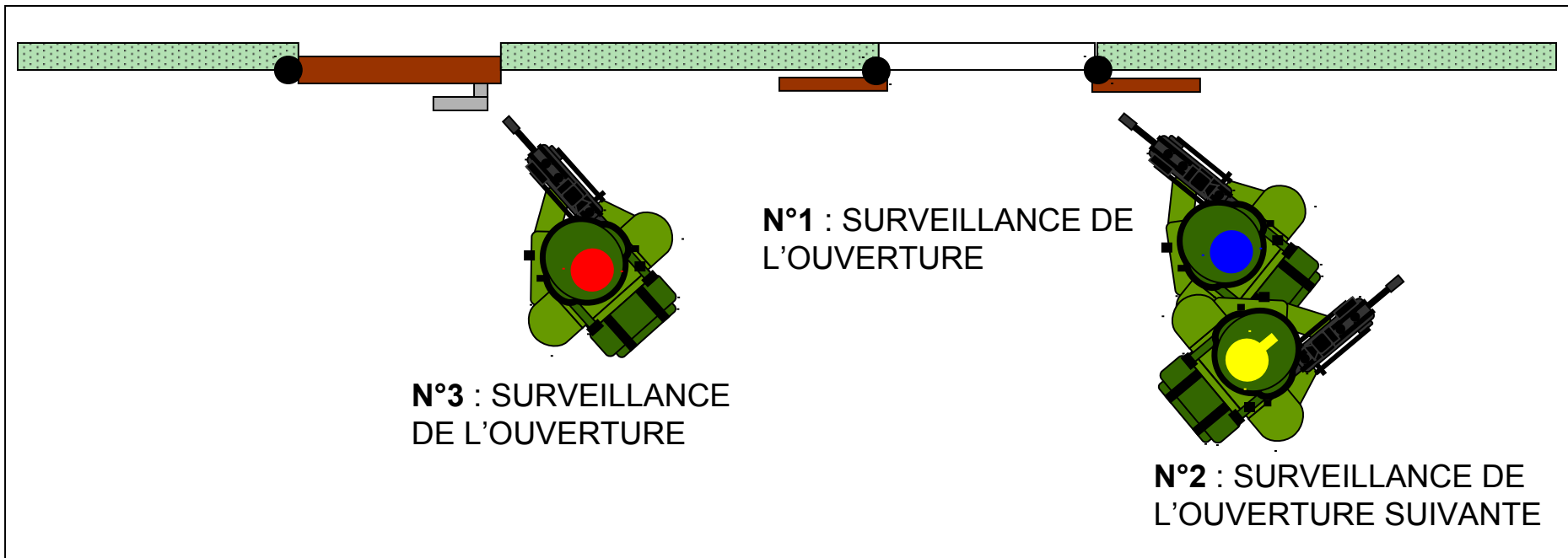



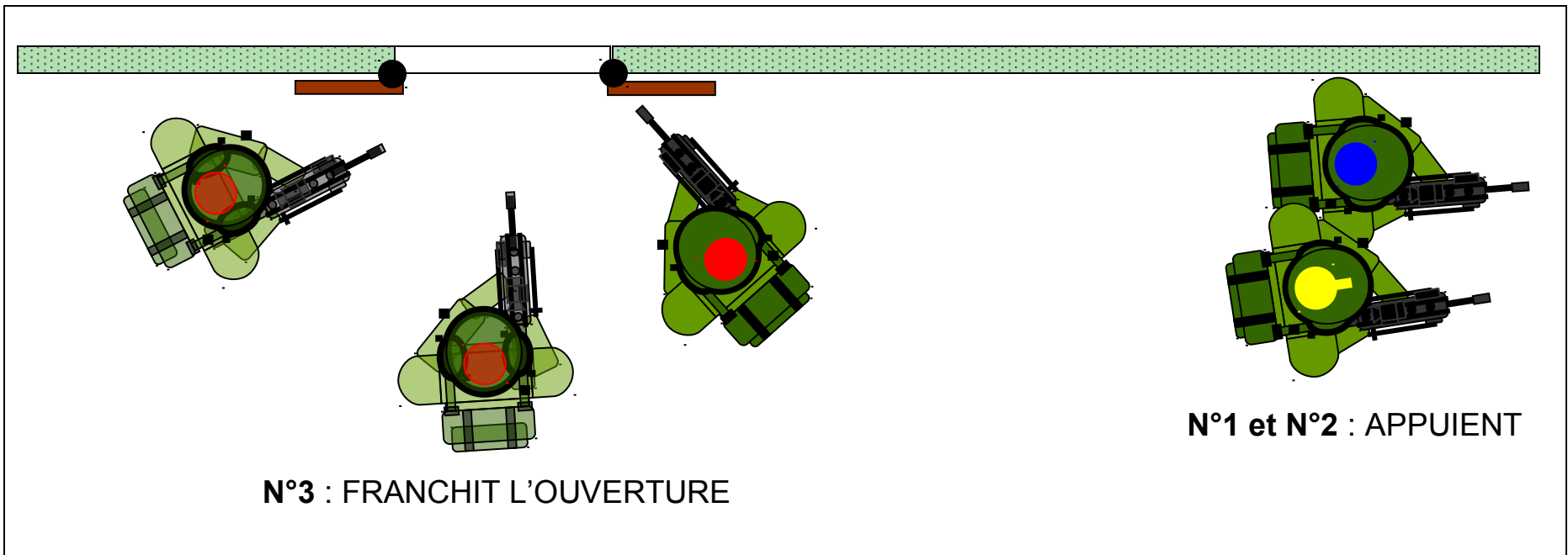
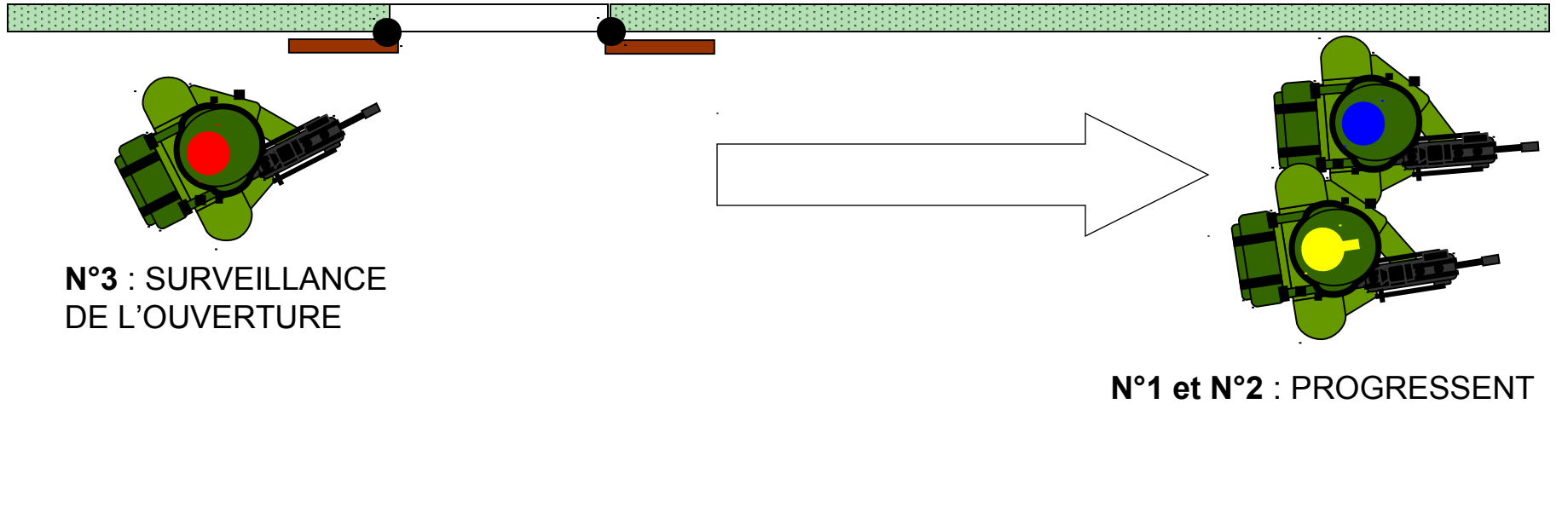

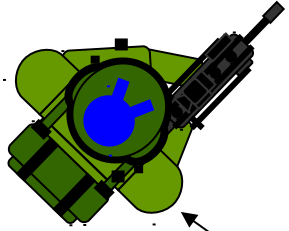

N°3 : APPUIE

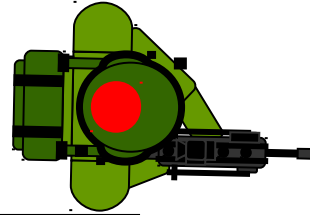

N°1 et N°2 : PROGRESSENT

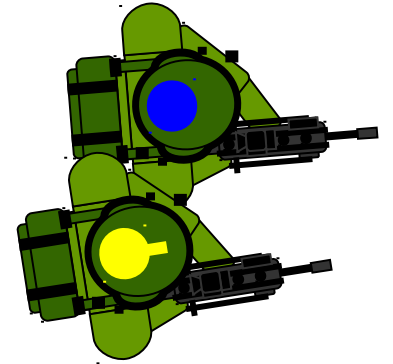

**NB** : PRISE EN COMPTE DE LA DERNIERE OUVERTURE  
PAR LE TRINÔME SUIVANT

**DEPLACEMENT GROUPE**

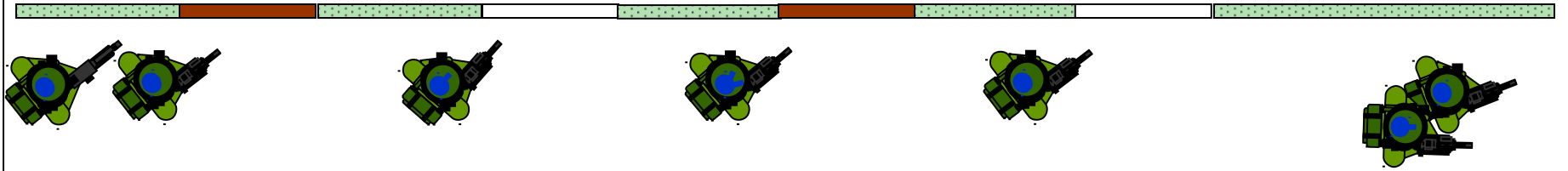

**NB** : GROUPE EN DEPLACEMENT LE LONG DE LA FACADE, LE GROUPE S'ETALE SUR LA LONGUEUR

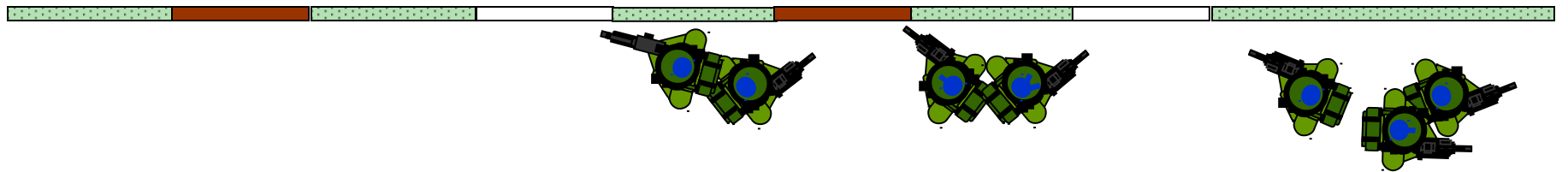

**NB** : GROUPE STATIQUE LE LONG DE LA FACADE, LE GROUPE SE RESSERRE.